

control
your comfort zone

PRIME
CATALOGUE 2025

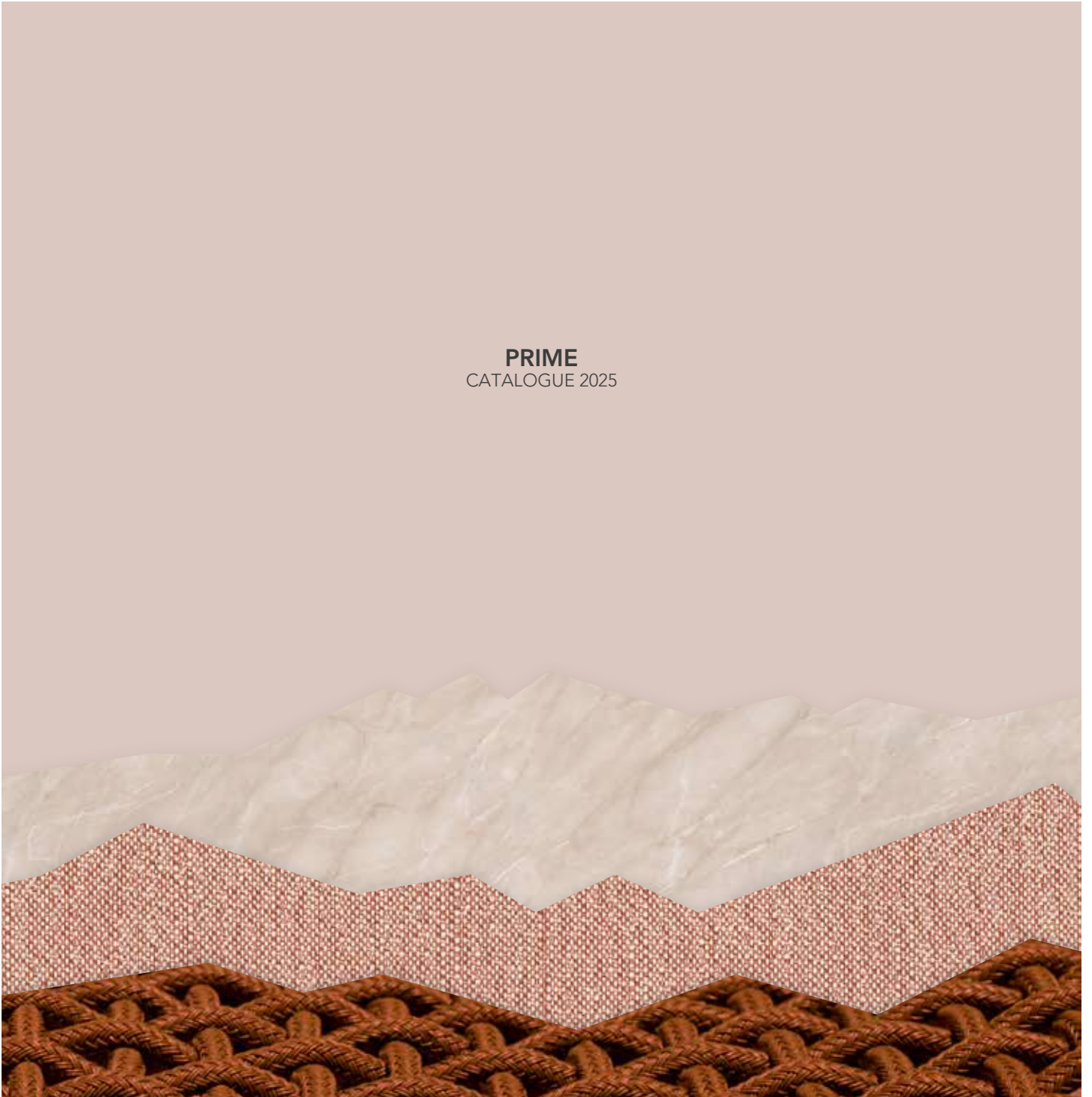



L'AZIENDA

Da oltre vent'anni, Contral è il punto di riferimento nel panorama dell'arredo outdoor. Nata nel 2001 e con sede a Villorba (TV), l'azienda si afferma sul mercato con particolare focus nel settore HORECA rappresentando la scelta ideale per chi desidera creare spazi all'aperto eleganti, funzionali e sostenibili. Ogni collezione è il frutto di un'attenta ricerca e di una costante evoluzione che ha permesso di interpretare i trend e le esigenze di una clientela sempre più attenta alla qualità e al design. Un percorso di crescita continua, per un futuro all'insegna del comfort e del rispetto per l'ambiente.

For over twenty years, Contral has been the leading player in the outdoor furniture scene. Founded in 2001 and headquartered in Villorba (TV), the company has established itself on the market with a particular focus on the HORECA sector, representing the ideal choice for those who want to create elegant, functional and sustainable outdoor spaces. Each collection is the result of careful research and constant evolution that has allowed us to interpret the trends and needs of customers who are constantly more attentive to quality and design. A path of continuous growth, for a future marked by comfort and respect for the environment.

MISSION

La missione di Contral è offrire soluzioni di ottima qualità, caratterizzate da uno stile raffinato ed elegante. Il nostro è un impegno costante al fine di migliorare l'esperienza di vita all'aperto dei nostri clienti, fornendo prodotti che, grazie alle caratteristiche tecniche e ai materiali sostenibili utilizzati, uniscono estetica e funzionalità, rispettando l'ambiente e promuovendo uno stile di vita in armonia con la natura.

Contral's mission is to offer high-quality solutions characterized by a refined and elegant style. We are committed to enhancing outdoor living experiences by providing products that combine aesthetics and functionality, thanks to the technical features and sustainable materials used, respecting the environment and promoting a lifestyle in harmony with nature.

CONSULENZA

Il team Contral mette costantemente a disposizione l'esperienza maturata negli anni, dimostrandosi un valido supporto sin dalla fase di progettazione. L'obiettivo è quello di offrire un servizio di consulenza personalizzata e la possibilità di toccare con mano la qualità dei prodotti presso lo showroom sito di Villorba (TV).

The Contral team constantly makes available the experience gained over the years, proving to be a valuable support from the project design stage. The goal is to offer a personalized consulting service and the opportunity to touch the quality of the products at the showroom located in Villorba (TV).

QUALITÀ

Scegliere Contral significa investire in un arredamento outdoor affidabile e di alta qualità, realizzato con materiali di prima scelta e scrupolosi processi produttivi. Grazie alla loro durevolezza e allo stile inconfondibile, i nostri prodotti arredano con successo le vie e le piazze di tutta Europa, resistendo ai rigori del Nord come al sole del Mediterraneo o all'imprevedibilità di Venezia.

Choosing Contral means investing in reliable, high-quality outdoor furniture, meticulously crafted with premium materials. Thanks to their durability and distinctive style, our products successfully furnish streets and squares across Europe, enduring the harsh northern climate, the Mediterranean sun, and even the unpredictable Venice weather.

ASSISTENZA

In Contral il rapporto con il cliente è fondamentale e imprescindibile. I nostri uffici vendita e post-vendita garantiscono un servizio di assistenza preciso e rapido, a dimostrazione del nostro impegno, ma soprattutto dell'immensa passione che unisce il nostro team.

At Contral, the relationship with the customer is fundamental and indispensable. Our sales and after-sales offices guarantee precise and prompt customer service, demonstrating our commitment, but above all, the immense passion that connects our team.





CONTENTS

PRODUCTS / COLLECTIONS

LAKE 8

LEAF 24

METHOD 42

CLOE 60

MANILA 68

BLED 80

DUB 90

DIVA 110

LADY 110

BERGEN 120

MEGAN 120

KARIN 120

NICOLE 120

GAUDÌ 136

PRAGA 136

ARIEL 136

DUKE 136

PAVILLON 148

HONOLULU 158

KUTA 160

AREA

TECNICA 162

Per una ricerca del prodotto per tipologia si può consultare l'indice prodotti a fine volume - pagina 174.

For a product search by type, you can consult the product index at the end of the book - page 174.

LAKE COLLECTION



Forma e funzionalità sono le caratteristiche che identificano la famiglia Lake. Il salotto è realizzato con un robusto telaio di alluminio, rivestito da una corda sintetica intrecciata a mano. La cuscineria è in tessuto 100% poliestere, sfoderabile. Il tavolino è in alluminio verniciato a polveri di poliestere con piano in HPL-Compact 12mm.

Design and functionality are the characteristics that identify Lake family. Built with a strong aluminum frame, this lounge is covered with a hand-woven synthetic rope. The cushions are made of 100% polyester fabric, with removable covers. The coffee table is in polyester powder-coated aluminum with 12mm HPL-Compact top.

COLORI / COLORS



AREA TECNICA / TECHNICAL AREA P. 164

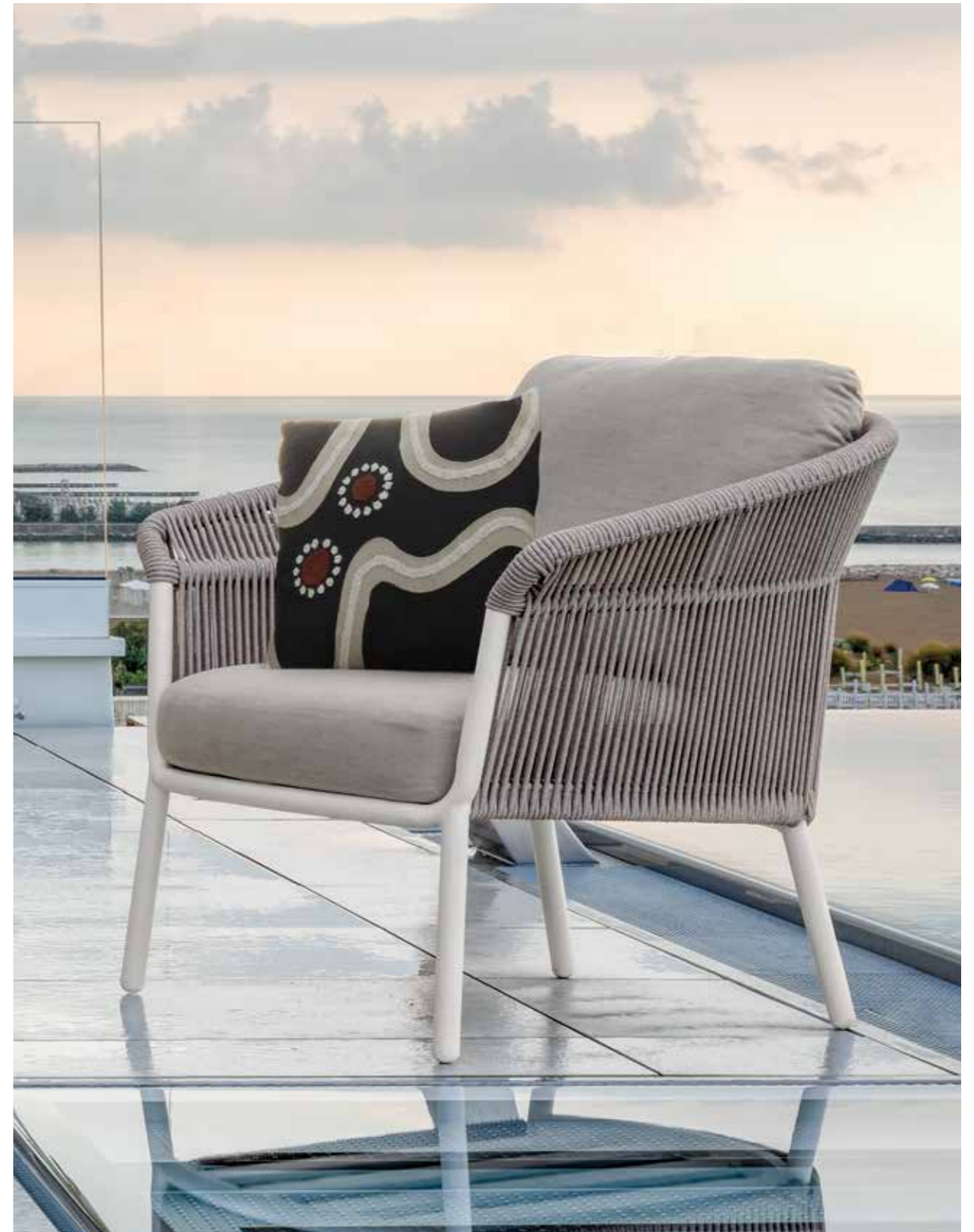





POLTRONA LAKE **COD 535/BCO**



DIVANO LAKE **COD 536/BCO**



TAVOLINO BERGEN **COD 547/BCO-EMP**





POLTRONA LAKE **COD 535/AT**



DIVANO LAKE **COD 536/AT**



TAVOLINO BERGEN **COD 547/AT-ARDE**



Poltroncina con telaio in alluminio verniciato a polveri di poliestere, schienale rivestito in corda sintetica intrecciata a mano. Il cuscino è in tessuto PVC, con imbottitura drenante e sfoderabile.

Armchair with polyester powder-coated aluminum frame, back is covered with hand-woven synthetic rope. The cushion has a removable PVC fabric cover and quick dry padding.



POLTRONCINA LAKE COD 732/BCO



POLTRONCINA LAKE COD 732/RED





POLTRONCINA LAKE COD 732/AT



POLTRONCINA LAKE COD 732/SEN



Sgabello con telaio in alluminio verniciato a polveri di poliestere, schienale rivestito in corda sintetica intrecciata a mano. Il cuscino è in tessuto PVC, con imbottitura drenante e sfoderabile. Il poggiatesta è rivestito in alluminio satinato.

Barstool with polyester powder-coated aluminum frame, back is covered with hand-woven synthetic rope. The cushion has a removable PVC fabric cover and quick dry padding. Footrest is protected by a satin-finished aluminum slat.



SGABELLO LAKE **COD 656/RED**



SGABELLO LAKE **COD 656/BCO**



SGABELLO LAKE **COD 656/AT**



SGABELLO LAKE **COD 656/SEN**

LEAF COLLECTION

E&PC Design



La collezione Leaf è preziosa per eleganza e leggerezza. Un solido telaio di alluminio, rivestito da una corda sintetica intrecciata a mano.

La cuscineria è in tessuto 100% poliestere, sfoderabile. Il tavolino è in alluminio verniciato a polveri di poliestere con piano in HPL-Compact 12mm.

The Leaf collection is precious for its elegance and lightness. The lounge is built on a solid aluminum frame, covered with a hand-woven synthetic rope. The cushions are made of 100% polyester fabric, with removable covers. The coffee table is in polyester powder-coated aluminum with 12mm HPL-Compact top.

COLORI / COLORS



AREA TECNICA / TECHNICAL AREA P. 164





POLTRONA LEAF DELUXE COD 569/TER



TAVOLINO LEAF MEDIUM COD 574/TER

La poltrona Leaf Deluxe è costruita su un solido telaio di alluminio, rivestito da una corda sintetica intrecciata a mano. La cuscineria è in tessuto 100% poliestere, sfoderabile. Il tavolino è in alluminio verniciato a polveri di poliestere con piano in HPL-Compact 12mm.

Leaf Deluxe armchair is built on a solid aluminum frame, covered with a hand-woven synthetic rope. The cushions are made of 100% polyester fabric, with removable covers. The coffee table is in polyester powder-coated aluminum with 12mm HPL-Compact top.



LEAF COLLECTION



POLTRONA LEAF **COD 570/TER**



DIVANO LEAF **COD 571/TER**



TAVOLINO LEAF BIG **COD 572/TER**



TAVOLINO LEAF SMALL **COD 573/TER**

Il salotto Leaf è costruito su un solido telaio di alluminio, rivestito da una corda sintetica intrecciata a mano. La cuscineria è in tessuto 100% poliestere, sfoderabile. Il tavolino è in alluminio verniciato a polveri di poliestere con piano in HPL-Compact 12mm.

The Leaf lounge set is built on a solid aluminum frame, covered with a hand-woven synthetic rope. The cushions are made of 100% polyester fabric, with removable covers. The coffee table is in polyester powder-coated aluminum with 12mm HPL-Compact top.





POLTRONA LEAF COD 570/AT



DIVANO LEAF COD 571/AT



TAVOLINO LEAF BIG COD 572/AT



TAVOLINO LEAF SMALL COD 573/AT





Poltroncina con telaio in alluminio verniciato a polveri di poliestere, schienale e seduta rivestiti in corda sintetica intrecciata a mano.

Leaf Dining armchair with polyester powder-coated aluminum frame, back and seat covered with a hand-woven synthetic rope.



POLTRONCINA LEAF **COD 711/TER**



POLTRONCINA LEAF **COD 711/BCO**



POLTRONCINA LEAF **COD 711/AT**



Sedia con telaio in alluminio verniciato a polveri di poliestere, schienale e seduta rivestiti in corda sintetica intrecciata a mano.

Leaf chair with polyester powder-coated aluminum frame, back and seat covered with a hand-woven synthetic rope.

SEDIA LEAF COD 710/TER



SEDIA LEAF COD 710/AT



SEDIA LEAF COD 710/BCO





Sgabello con telaio in alluminio verniciato a polveri di poliestere, schienale e seduta rivestiti in corda sintetica intrecciata a mano. Il poggiapiedi è rivestito in alluminio anodizzato.

Barstool with polyester powder-coated aluminum frame, back and seat covered with a hand-woven synthetic rope. Footrest is protected by an anodized-finished aluminum slat.



SGABELLO LEAF **COD 663/TER**



SGABELLO LEAF **COD 663/BCO**



SGABELLO LEAF **COD 663/AT**

METHOD COLLECTION



Questa linea elegante offre un disegno contemporaneo che ne esalta la comodità e la raffinatezza.

Costruito su un solido telaio in alluminio, questo salotto è rivestito da una corda sintetica 12mm intrecciata a mano. La cuscineria è in tessuto 100% poliestere, sfoderabile e una guaina sintetica termosaldata riveste l'imbottitura e la rende impermeabile. Il tavolino è in alluminio verniciato a polveri poliesteri con piano HPL-Compact da 12 mm.

This refined line offers a contemporary design that enhances its comfort and elegance. Built on a solid aluminum structure, this lounge is covered with hand woven 12mm synthetic rope.

Seats are lined by 100% polyester fabric, removable. A thermosealed synthetic shell covers the padding completely and makes it waterproof. The coffee table is in polyester powder-coated aluminum with 12mm HPL-Compact top.

COLORI / COLORS



AREA TECNICA / TECHNICAL AREA P. 166







POLTRONA METHOD **COD 565/AT34**



DIVANO METHOD **COD 566/AT34**



TAVOLINO DOVER **COD 523/AT-MAGR**





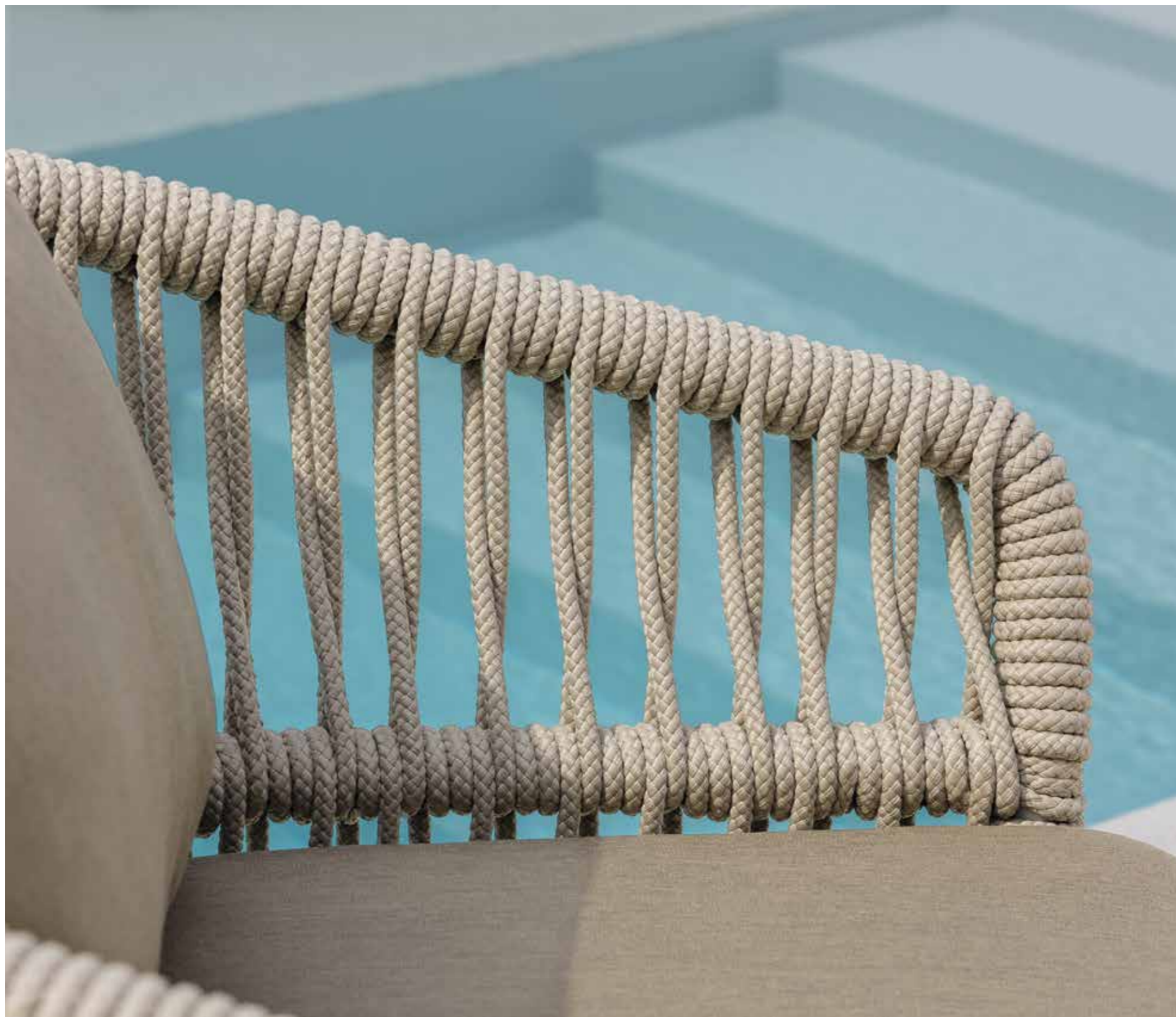

POLTRONA METHOD **COD 565/BCO02**



DIVANO METHOD **COD 566/BCO02**



TAVOLINO DOVER **COD 523/TAU-EMP**



Poltroncina con telaio in alluminio verniciato a polveri poliesteri, rivestita con corda sintetica intrecciata a mano. Il cuscino della seduta è in tessuto PVC, con imbottitura drenante, sfoderabile.

Dining armchair with polyester powder-coated aluminum frame, covered with hand-woven synthetic rope. Seat cushion is PVC fabric, with draining padding, removable cover.



POLTRONCINA METHOD COD 715/VER13



POLTRONCINA METHOD COD 715/AT34



POLTRONCINA METHOD COD 715/BC002





Sgabello con telaio in alluminio verniciato a polveri poliesteri, rivestito con corda sintetica intrecciata a mano. Il cuscino della seduta è in tessuto PVC, con imbottitura drenante, sfoderabile. Il poggiapiedi è rivestito in alluminio anodizzato.

Barstool with polyester powder-coated aluminum frame, covered with hand-woven synthetic rope. The seat cushion is PVC fabric, with draining padding, removable cover. Footrest is protected by an anodized-finished aluminum slat.



SGABELLO METHOD COD 660/BCO02



SGABELLO METHOD COD 660/VER13



SGABELLO METHOD COD 660/AT34

CLOE COLLECTION



La nuova collezione Cloe reinventa l'essenziale, proponendo un design contemporaneo e un'estrema cura per i dettagli.

Le poltroncine e gli sgabelli sono realizzati con un solido telaio in alluminio verniciato a polveri di poliestere e rivestiti da una corda sintetica intrecciata a mano.

The new Cloe collection reinterprets the essential, offering a contemporary design and an extreme attention to detail. Dining armchairs and barstools are made of solid powder-coated aluminum frame and covered with hand-woven synthetic rope.

COLORI / COLORS

AREA TECNICA / TECHNICAL AREA P. 166





Poltroncina con telaio in alluminio verniciato a polveri di poliestere, schienale e seduta rivestiti in corda sintetica intrecciata a mano. Braccioli con inserti in Tech-no Wood.

Armchair with polyester powder-coated aluminum frame, seat and back are covered with hand-woven synthetic rope. Armrests with Tech-no Wood inserts.



POLTRONCINA CLOE COD 730/BJ



POLTRONCINA CLOE COD 730/VER



POLTRONCINA CLOE COD 730/BL

CLOE COLLECTION



Sgabello con telaio in alluminio verniciato a polveri di poliestere, schienale e seduta rivestiti in corda sintetica intrecciata a mano. Il poggiapiedi è rivestito in alluminio satinato.

Barstool with polyester powder-coated aluminum frame, seat and back are covered with hand-woven synthetic rope. Footrest is protected by a satin-finished aluminum slat.



SGABELLO CLOE COD 659/BJ



SGABELLO CLOE COD 659/VER



SGABELLO CLOE COD 659/BL

MANILA COLLECTION



La nuova famiglia Manila è una collezione che esprime un sistema di cordatura articolato conferendo al prodotto una personalità unica. I telai dei modelli sono costruiti in solido alluminio verniciato a polveri di poliestere. Gli schienali sono rivestiti da una corda sintetica 12 mm intrecciata a mano, la cuscineria è in tessuto 100% poliestere, sfoderabile. Il tavolino è in alluminio verniciato a polveri di poliestere con piano HPL-Compact da 12mm.

The new Manila family is a collection that represents an elaborated stringing system which gives the product a unique personality. The frames are made of solid polyester powder-coated aluminum. The backrests are covered with a hand-woven 12mm synthetic rope, and the cushions are 100% polyester fabric, removable. The coffee table is in polyester powder-coated aluminum with 12mm HPL-Compact top.

COLORI / COLORS



AREA TECNICA / TECHNICAL AREA P. 167







POLTRONA MANILA COD 567/BCO31



DIVANO MANILA COD 568/BCO31



TAVOLINO DOVER COD 523/BCO-EMP



POLTRONA MANILA COD 567/AT35



DIVANO MANILA COD 568/AT35



TAVOLINO DOVER COD 523/AT-ARDE

Poltroncina con telaio in alluminio verniciato a polveri di poliestere, rivestita con corda sintetica intrecciata a mano. Il cuscino della seduta è in tessuto PVC, con imbottitura drenante, sfoderabile.

Dining armchair with polyester powder-coated aluminum frame, covered with hand-woven synthetic rope. Seat cushion is PVC fabric, with draining padding, removable covers.



POLTRONCINA MANILA COD 716/AT35



POLTRONCINA MANILA COD 716/BC031



POLTRONCINA MANILA COD 716/VER13

MANILA COLLECTION



Sgabello con telaio in alluminio verniciato a polveri di poliestere, rivestito in corda sintetica intrecciata a mano. Il cuscino della seduta è in tessuto PVC, con imbottitura drenante, sfoderabile. Il poggiapiedi è rivestito in alluminio anodizzato.

Barstool with polyester powder-coated aluminum frame, covered with hand-woven synthetic rope. Seat cushion is PVC fabric with draining padding, removable covers. Footrest is protected by an anodized-finished aluminum slat.

SGABELLO MANILA COD 664/BCO31



SGABELLO MANILA COD 664/VER13



SGABELLO MANILA COD 664/AT35



BLED COLLECTION



Elegante e ricercato, il salotto Bled si presenta con un telaio in alluminio verniciato a polveri di poliestere e un raffinato rivestimento in corda sintetica intrecciata a mano. I cuscini sono sfoderabili, con rivestimento in tessuto 100% poliestere. Il tavolino è in alluminio verniciato a polveri di poliestere con piano HPL-Compact da 12 mm.

Elegant and sophisticated, the Bled lounge set has a polyester powder-coated aluminum structure, finely covered with a hand-woven synthetic rope. Cushions have removable covers, 100% polyester fabric. The coffee table is in polyester powder-coated aluminum with 12mm HPL-Compact top.

COLORI / COLORS



AREA TECNICA / TECHNICAL AREA P. 167







POLTRONA BLED COD 527/TAU



DIVANO BLED COD 528/TAU



TAVOLINO DOVER COD 523/TAU-EMP





POLTRONA BLED COD 527/AT



DIVANO BLED COD 528/AT



TAVOLINO DOVER COD 523/AT-ARDE



Poltroncina con telaio in alluminio verniciato a polveri di poliestere. Schienale rivestito in corda sintetica intrecciata a mano. Il cuscino è in tessuto PVC, con imbottitura drenante e sfoderabile.

Dining armchair with polyester powder-coated aluminum frame. Back is lined with a hand-woven synthetic rope. The cushion has a removable PVC fabric cover and quick dry padding.



POLTRONCINA BLED COD 722/AT



POLTRONCINA BLED COD 722/TAU

DUB COLLECTION



Il salotto Dub, distinto da un design accattivante, è costruito su una solida struttura di alluminio verniciata a polveri di poliestere. Gli schienali sono rivestiti con un tubolare in tessuto sintetico con imbottitura in gomma ed intrecciati a mano. I cuscini sono sfoderabili con rivestimento in tessuto 100% poliestere. Il tavolino è in alluminio verniciato a polveri di poliestere con piano HPL-Compact da 12 mm.

Defined by a captivating design, the Dub lounge set is built on a solid, polyester powder-coated aluminum structure. The backs are covered with a hand-woven synthetic fabric tubular padded with rubber. Cushions have removable covers, 100% polyester fabric. The coffee table is in polyester powder coated aluminum with 12mm HPL-Compact top.

COLORI / COLORS



AREA TECNICA / TECHNICAL AREA P. 168





POLTRONA DUB COD 500/AT04



DIVANO DUB COD 501/AT04



TAVOLINO DOVER COD 523/AT-GAL





POLTRONA DUB COD 500/AT35



DIVANO DUB COD 501/AT35



TAVOLINO DOVER COD 523/AT-ARDE







POLTRONA DUB COD 500/BCO02



DIVANO DUB COD 501/BCO02



TAVOLINO DOVER COD 523/BCO-EMP







Poltroncina con telaio in alluminio verniciato a polveri di poliestere. Schienale rivestito in tubolare di tessuto sintetico con imbottitura di gomma. Il cuscino è in tessuto PVC, con imbottitura drenante e sfoderabile.

Dining armchair with polyester powder-coated aluminum frame. Back is covered with a hand-woven synthetic fabric tubular padded with rubber. The cushion has a removable PVC fabric cover and quick dry padding.



POLTRONCINA DUB **COD 718/BC002**



POLTRONCINA DUB COD 718/AT35



POLTRONCINA DUB COD 718/AT04



Sgabello con telaio in alluminio verniciato a polveri di poliestere. Schienale rivestito in tubolare di tessuto sintetico con imbottitura di gomma. Il cuscino è in tessuto PVC, con imbottitura drenante e sfoderabile. Il poggiapiedi è rivestito in alluminio anodizzato.

Barstool with polyester powder-coated aluminum frame. Back is covered with a hand-woven synthetic fabric tubular padded with rubber. The cushion has a removable PVC fabric cover and quick dry padding. Footrest is protected by an anodized-finished aluminum slat.



SGABELLO DUB COD 655/BC02



SGABELLO DUB COD 655/AT35



SGABELLO DUB COD 655/AT04



DIVA LADY



Un salotto dallo stile leggero e raffinato, Diva è caratterizzato da schienali rivestiti in corda sintetica e una solida struttura in alluminio verniciato a polveri di poliestere. I cuscini sono in tessuto 100% poliestere, sfoderabili. Viene proposto con divano a due o tre posti. Il tavolino è in alluminio verniciato a polveri di poliestere con piano HPL-Compact da 12 mm.

A lounge set with a refined and light presence, Diva is characterized by backrests woven with synthetic rope and a solid structure made of polyester powder-coated aluminum. Cushions have removable covers, 100% polyester fabric. It is offered with two or three seater sofa. The coffee table is in polyester powder-coated aluminum with 12mm HPL-Compact top.

COLORI / COLORS



AREA TECNICA / TECHNICAL AREA P. 169







POLTRONA DIVA COD 505



DIVANO 2 POSTI DIVA COD 506



DIVANO 3 POSTI DIVA COD 507



TAVOLINO DIVA COD 508

DIVA

I cuscini sono in tessuto 100% poliestere, sfoderabili. Il tavolino è in alluminio verniciato a polveri di poliestere con piano HPL-Compact da 12 mm.

Cushions have removable covers, 100% polyester fabric. The coffee table is in polyester powder-coated aluminum with 12mm HPL-Compact top.

**LADY**

Poltroncina con telaio in alluminio verniciato a polveri di poliestere. Schienale rivestito in corda sintetica. Il cuscino è in tessuto 100% poliestere, con imbottitura sfoderabile.

Dining armchair with polyester powder-coated aluminum frame. Back is covered with a hand-woven synthetic rope. The cushion has a removable 100% polyester fabric cover.

POLTRONCINA LADY **COD 720**

**DIVA**

Sgabello con telaio in alluminio verniciato a polveri di poliestere. Schienale rivestito in corda sintetica. Il cuscino è in tessuto 100% poliestere, con imbottitura sfoderabile.

Barstool with polyester powder-coated aluminum-frame. Back is covered with a hand-woven synthetic rope. The cushion has a removable 100% polyester fabric cover.

DIVASGABELLO DIVA **COD 650**

BERGEN MEGAN KARIN NICOLE



Una snella e robusta struttura tubolare di alluminio verniciato a polveri di poliestere e un rivestimento in corda sintetica piatta caratterizzano il prezioso salotto Bergen. I cuscini sono in tessuto 100% poliestere e sfoderabili. Viene proposto con divano a due o tre posti. Il tavolino è in alluminio verniciato a polveri di poliestere con piano in vetro temperato o in HPL-Compact da 12 mm.

A slim and solid tubular structure of polyester powder-coated aluminum and hand-woven flat synthetic rope coverings define the precious Bergen lounge set. Cushions have removable covers, 100% polyester fabric. It is offered with two or three seater sofa. The coffee table is in polyester powder-coated aluminum with tempered glass or 12mm HPL-Compact top.

COLORI / COLORS



AREA TECNICA / TECHNICAL AREA P. 169







POLTRONA BERGEN COD 542/AT



DIVANO 2 POSTI BERGEN COD 543/AT



DIVANO 3 POSTI BERGEN COD 544/AT



Il tavolino Bergen è in alluminio verniciato a polveri di poliestere con piano in vetro temperato o in HPL-Compact da 12 mm.

The coffee table is in polyester powder-coated aluminum with tempered glass or 12mm HPL-Compact top.



TAVOLINO BERGEN COD 545/AT



TAVOLINO BERGEN COD 547/AT-FOS



TAVOLINO BERGEN COD 547/AT-ARDE

MEGAN

Poltroncina con telaio in alluminio verniciato a polveri di poliestere. Schienale rivestito in corda sintetica piatta. Il cuscino è in tessuto PVC, con imbottitura drenante e sfoderabile.

Dining armchair with polyester powder-coated aluminum frame. Back is covered with a hand-woven synthetic flat rope. The cushion has a removable PVC fabric cover and quick dry padding.



POLTRONCINA MEGAN COD 728/AT



MEGAN

**KARIN**

Poltroncina con telaio in alluminio verniciato a polveri di poliestere. Schienale rivestito in corda sintetica piatta. Il cuscino è in tessuto PVC, con imbottitura drenante e sfoderabile.

Dining armchair with polyester powder-coated aluminum frame. Back is covered with a hand-woven synthetic flat rope. The cushion has a removable PVC fabric cover and quick dry padding.



POLTRONCINA KARIN COD 726/AT



CUSCINO KARIN+MEGAN COD 1530/04



CUSCINO KARIN+MEGAN COD 1530/98



CUSCINO / CUSHION

Cuscino opzionale seduta e schienale per poltroncine Karin e Megan. In tessuto 100% poliestere, sfoderabile e con lacci per fissaggio in velcro.

Seat and back optional cushion for Karin and Megan armchairs. In 100% polyester fabric, with removable cover and velcro strips to attach it.

NICOLE

Sedia con telaio in alluminio verniciato a polveri di poliestere. Schienale rivestito in corda sintetica piatta. Il cuscino è in tessuto PVC, con imbottitura drenante e sfoderabile.

Chair with polyester powder-coated aluminum frame. Back is covered with a hand-woven synthetic flat rope. The cushion has a removable PVC fabric cover and quick dry padding.



SEDIA NICOLE COD 727/AT



NICOLE



LETTINO BERGEN COD 604/AT

Lettino con struttura in alluminio verniciato a polveri di poliestere rivestita in corda sintetica piatta. Dotato di ruote e con schienale regolabile in sei posizioni. Cuscino in tessuto 100% poliestere sfoderabile.

Sunlounger with a polyester powder-coated aluminum structure lined with hand woven flat synthetic rope. With wheels and six positions adjustable back. The cushion has a removable cover, 100% polyester fabric.



GAUDÌ PRAGA ARIEL DUKE



Poltroncine, sedie e sgabelli con telaio in alluminio verniciato a polveri di poliestere. Schienali rivestiti in corda sintetica intrecciata a mano e sedute in tessuto PVC.

Dining armchairs, chairs and barstools with polyester powder-coated aluminum frames. Backs are covered with a hand-woven synthetic rope and the seats made of PVC fabric.

COLORI / COLORS



AREA TECNICA / TECHNICAL AREA P. 170

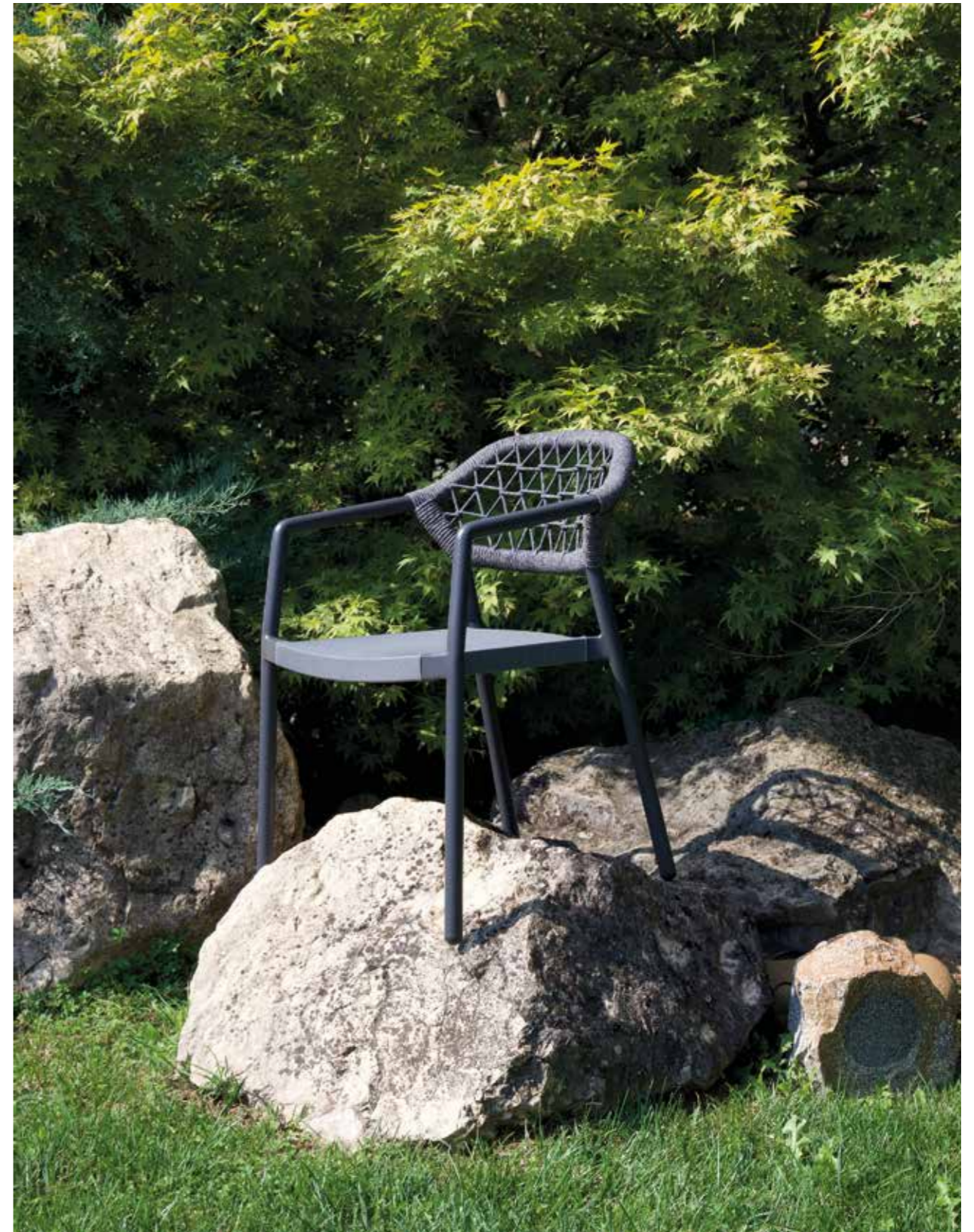



GAUDÌ

Poltroncina con telaio in alluminio verniciato a polveri di poliestere. Schienale rivestito in corda sintetica intrecciata a mano. La seduta è in tessuto plastico PVC.

Dining armchair with polyester powder-coated aluminum frame. The back is lined with a hand-woven synthetic rope and the seat is made of PVC fabric.



POLTRONCINA GAUDÌ COD 731/TAU



POLTRONCINA GAUDÌ COD 731/AT



GAUDÌ



PRAGA

Poltroncina con telaio in alluminio verniciato a polveri di poliestere. Schienale rivestito in corda sintetica intrecciata a mano e seduta in tessuto PVC.

Dining armchair with polyester powder-coated aluminum frame. Back is covered with a hand-woven synthetic rope and the seat is made of PVC fabric.



POLTRONCINA PRAGA COD 793/BCO



POLTRONCINA PRAGA COD 793/TAU



POLTRONCINA PRAGA COD 793/AT



SEDIA ARIEL COD 794/BCO



SEDIA ARIEL COD 794/TAU



SEDIA ARIEL COD 794/AT



ARIEL

Sedia con telaio in alluminio verniciato a polveri di poliestere. Schienale rivestito in corda sintetica intrecciata a mano e seduta in tessuto PVC.

Chair with polyester powder-coated aluminum frame. Back is covered with a hand-woven synthetic rope and the seat is made of PVC fabric.

DUKE

Sgabello con telaio in alluminio verniciato a polveri di poliestere. Schienale rivestito in corda sintetica intrecciata a mano. La seduta è in tessuto plastico PVC. Il poggiapiedi è rivestito in alluminio satinato.

Barstool with polyester powder-coated aluminum frame. The back is lined with a hand-woven synthetic rope and the seat is made of PVC fabric. Footrest is protected by a satin-finished aluminum slat.

SGABELLO DUKE **COD 658/AT**SGABELLO DUKE **COD 658/TAU**

PAVILLON SERVICE



Il Pavillon Service è la scelta ideale per i tuoi eventi all'esterno anche al mutare delle condizioni atmosferiche. La struttura è pensata e realizzata per ampliare lo spazio di lavoro esterno, è in alluminio verniciato a polveri poliesteri, è amovibile ed è dotata di tetto bioclimatico, bancone e cucina. I tre lati aperti si possono chiudere con un telo in PVC, meccanicamente o manualmente. Grill non incluso.

The Pavillon Service is the ideal choice for your outdoor events even in changing weather conditions. The structure is designed and built to expand your outdoor work space, is made of polyester powder-coated aluminum, is removable and is equipped with a bioclimatic roof, counter and sink. The open sections can be easily closed by PVC curtains, electrically or manually. Grill not included.

AREA TECNICA / TECHNICAL AREA P. 171







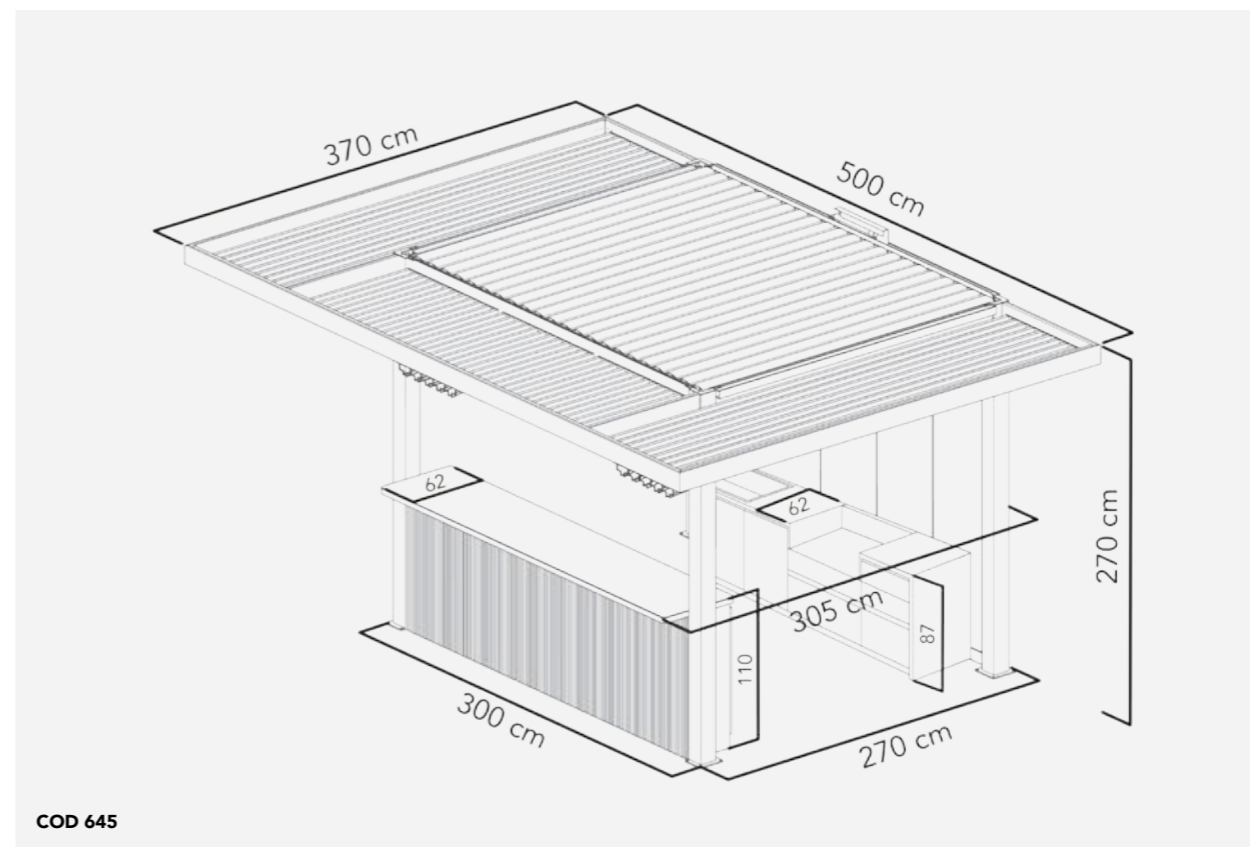

COD 645

GAZEBO

Letti prendisole a baldacchino con strutture in alluminio verniciate a polveri di poliestere, coperture in tessuto sintetico e cuscini idrorepellenti. Studiati per resistere alle intemperie e adatti anche per ambienti marini.

Canopy sunbeds with polyester powder-coated aluminum structures, synthetic fabric covers and water-repellant cushions. Designed to withstand the weather and also suitable for marine environments.

AREA TECNICA / TECHNICAL AREA P. 171



HONOLULU

Il gazebo Honolulu è pensato per valorizzare spazi esterni creando un'atmosfera magica e rilassante. Honolulu ha una struttura in alluminio verniciata a polveri di poliestere; le mensole, le doghe ed il calpestio sono in alluminio ad effetto teak.

È dotato di materasso con schienali reclinabili separatamente, sfoderabile e con imbottitura drenante. La copertura prevede un telo in tessuto plastico PVC.

Honolulu gazebo was designed to enrich outdoor spaces creating a magical and relaxing atmosphere. The main frame is made of polyester powder-coated aluminum; shelves, roof slats and the decking are made of aluminum with teak effect. It features a bed with independent reclining backrests, removable cushion cover and quick dry foam padding. The roof is covered with a plastic PVC sling shade.



HONOLULU GAZEBO COD 640



KUTA

Il gazebo Kuta è stato ideato per allestire spazi esterni con eleganza e semplicità. Tutta la struttura è in alluminio verniciato a polveri di poliestere, garantendo una elevata resistenza agli agenti atmosferici e durevolezza. Gli schienali del lettino sono reclinabili separatamente. Il tessuto dei materassi è 100% poliestere e l'imbottitura è drenante e sfoderabile. Il cielino è regolabile per proteggere dai raggi solari ed è in tessuto PVC.

Kuta Gazebo was designed to furnish outdoor spaces with elegance and simplicity. The entire structure is polyester powder-coated aluminum, guaranteeing high resistance to weathering and durability. The backrests of the bed can be reclined separately. The cushion has a removable cover, 100% polyester fabric and quick dry foam padding. The PVC roof is adjustable to provide excellent protection against the sun's UV rays.



KUTA GAZEBO COD 642



AREA TECNICA

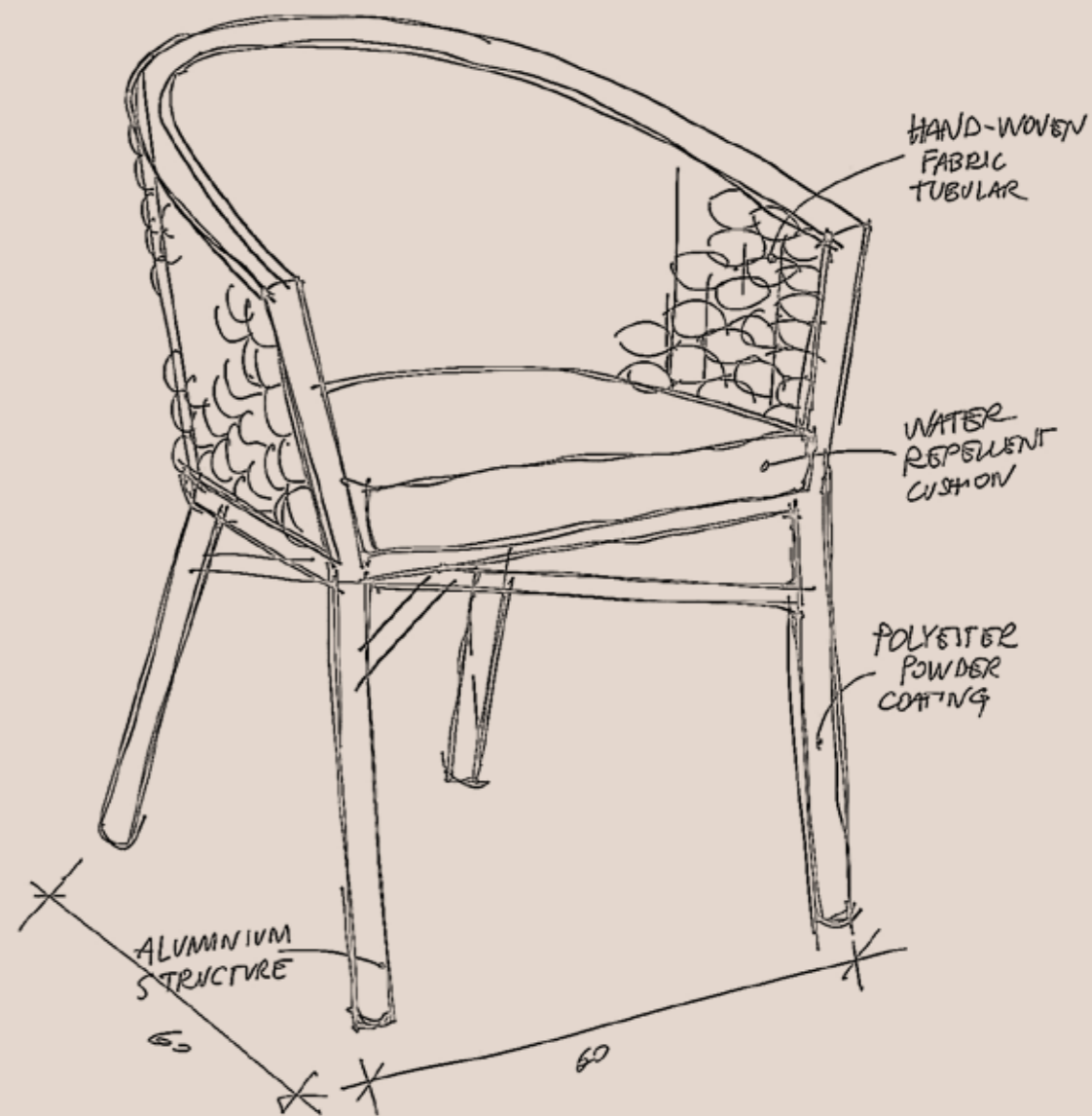

Articoli che possono essere utilizzati all'esterno
These products may be used outdoors



Articoli che possono essere utilizzati all'esterno coperto
These products are suitable for protected outdoor areas



Larghezza
Width



Profondità
Depth



Altezza
Height



Altezza seduta
Seat's height



Larghezza seduta
Seat's width



Numero di pezzi impilabili
Stackable pieces



Peso (in kg)
Weight (in kg)

LAKE COLLECTION



pag 16
LAKE
 POLTRONA / LOUNGE ARMCHAIR
 cod 535/AT
 P92 h84 h80 h143 X2



pag 13
LAKE
 POLTRONA / LOUNGE ARMCHAIR
 cod 535/BCO
 P92 h84 h80 h143 X2



pag 16
LAKE
 DIVANO / 2 SEATER SOFA
 cod 536/AT
 P176 h84 h80 h143 X2



pag 13
LAKE
 DIVANO / 2 SEATER SOFA
 cod 536/BCO
 P176 h84 h80 h143 X2



pag 16
BERGEN
 TAVOLINO / COFFEE TABLE
 cod 547/AT-ARDE
 P75 P75 P28



pag 13
BERGEN
 TAVOLINO / COFFEE TABLE
 cod 547/BCO-EMP
 P75 P75 P28



pag 18
LAKE
 POLTRONCINA / ARMCHAIR
 cod 732/BCO
 P61 h57,5 h77 h149 X43 X5



pag 18
LAKE
 POLTRONCINA / ARMCHAIR
 cod 732/RED
 P61 h57,5 h77 h149 X43 X5



pag 20
LAKE
 POLTRONCINA / ARMCHAIR
 cod 732/AT
 P61 h57,5 h77 h149 X43 X5



pag 20
LAKE
 POLTRONCINA / ARMCHAIR
 cod 732/SEN
 P61 h57,5 h77 h149 X43 X5



pag 23
LAKE
 SGABELLO / STOOL
 cod 656/RED
 P60 h58 h106 h84 X42



pag 23
LAKE
 SGABELLO / STOOL
 cod 656/AT
 P60 h58 h106 h84 X42



pag 23
LAKE
 SGABELLO / STOOL
 cod 656/BCO
 P60 h58 h106 h84 X42



pag 23
LAKE
 SGABELLO / STOOL
 cod 656/SEN
 P60 h58 h106 h84 X42



pag 27
LEAF
 POLTRONA DELUXE / DELUXE ARMCHAIR
 cod 569/TER
 P74 h85 h100,5 h140 X54



pag 34
LEAF
 POLTRONA / LOUNGE ARMCHAIR
 cod 570/AT
 P76 h74 h78 h140,5 X4



pag 31
LEAF
 POLTRONA / LOUNGE ARMCHAIR
 cod 570/TER
 P76 h74 h78 h140,5 X4



pag 34
LEAF
 DIVANO / 2 SEATER SOFA
 cod 571/AT
 P150 h74 h78 h140,5 X4



pag 31
LEAF
 DIVANO / 2 SEATER SOFA
 cod 571/TER
 P150 h74 h78 h140,5 X4



pag 27
LEAF
 TAVOLINO MEDIUM / MEDIUM COFFEE TABLE
 cod 574/TER
 P55 P55 P36



pag 34
LEAF
 TAVOLINO BIG / BIG TABLE
 cod 572/AT
 P92 P54,5 P32



pag 31
LEAF
 TAVOLINO BIG / BIG TABLE
 cod 572/TER
 P92 P54,5 P32



pag 34
LEAF
 TAVOLINO SMALL / SMALL TABLE
 cod 573/AT
 P45 P45 P38



pag 31
LEAF
 TAVOLINO SMALL / SMALL TABLE
 cod 573/TER
 P45 P45 P38



pag 37
LEAF
 POLTRONCINA / ARMCHAIR
 cod 711/AT
 P58,5 h63 h81 h146,5 X42 X5



pag 37
LEAF
 POLTRONCINA / ARMCHAIR
 cod 711/BCO
 P58,5 h63 h81 h146,5 X42 X5



pag 37
LEAF
 POLTRONCINA / ARMCHAIR
 cod 711/TER
 P58,5 h63 h81 h146,5 X42 X5



pag 38
LEAF
 SEDIA / CHAIR
 cod 710/AT
 P53 h66 h81 h146,5 X41 X5



pag 38
LEAF
 SEDIA / CHAIR
 cod 710/BCO
 P53 h66 h81 h146,5 X41 X5



pag 38
LEAF
 SEDIA / CHAIR
 cod 710/TER
 P53 h66 h81 h146,5 X41 X5



pag 41
LEAF
 SGABELLO / BARSTOOL
 cod 663/AT
 P48 h59 h102 h173 X42



pag 41
LEAF
 SGABELLO / BARSTOOL
 cod 663/BCO
 P48 h59 h102 h173 X42

LEAF COLLECTION

METHOD COLLECTION



pag 41
LEAF
SGABELLO / BARSTOOL
cod 663/TER
P48 h59 h102 h73 P42



pag 46
METHOD
POLTRONA / LOUNGE ARMCHAIR
cod 565/AT34
P103 h89,5 h74 h40



pag 51
METHOD
POLTRONA / LOUNGE ARMCHAIR
cod 565/BCO02
P103 h89,5 h74 h40



pag 46
METHOD
DIVANO / 2 SEATER SOFA
cod 566/AT34
P172 h89,5 h74 h40



pag 51
METHOD
DIVANO / 2 SEATER SOFA
cod 566/BCO02
P172 h89,5 h74 h40



pag 46
DOVER
TAVOLINO / COFFEE TABLE
cod 523/AT-MAGR
P95 P59 P36



pag 51
DOVER
TAVOLINO / COFFEE TABLE
cod 523/TAU-EMP
P95 P59 P36



pag 53
METHOD
POLTRONCINA / DINING ARMCHAIR
cod 715/VER13
P62 h58 h79 h48 P49 X5



pag 54
METHOD
POLTRONCINA / DINING ARMCHAIR
cod 715/AT34
P62 h58 h79 h48 P49 X5



pag 54
METHOD
POLTRONCINA / DINING ARMCHAIR
cod 715/BCO02
P62 h58 h79 h48 P49 X5



pag 57
METHOD
SGABELLO / BARSTOOL
cod 660/BCO02
P60 h55 h105 h76 P42,5



pag 59
METHOD
SGABELLO / BARSTOOL
cod 660/VER13
P60 h55 h105 h76 P42,5



pag 59
METHOD
SGABELLO / BARSTOOL
cod 660/AT34
P60 h55 h105 h76 P42,5



pag 65
CLOE
POLTRONCINA / DINING ARMCHAIR
cod 730/BL
P58 h58 h83 h46 P49,5 X7



pag 65
CLOE
POLTRONCINA / DINING ARMCHAIR
cod 730/VER
P58 h58 h83 h46 P49,5 X7



pag 65
CLOE
POLTRONCINA / DINING ARMCHAIR
cod 730/BJ
P58 h58 h83 h46 P49,5 X7

CLOE COLLECTION

MANILA COLLECTION



pag 67
CLOE
SGABELLO / BARSTOOL
cod 659/BL
P55 h55 h110 h81 P41 X6



pag 67
CLOE
SGABELLO / BARSTOOL
cod 659/VER
P55 h55 h110 h81 P41 X6



pag 67
CLOE
SGABELLO / BARSTOOL
cod 659/BJ
P55 h55 h110 h81 P41 X6



pag 73
MANILA
POLTRONA / LOUNGE ARMCHAIR
cod 567/BCO31
P77 h78 h74 h45 X2



pag 75
MANILA
POLTRONA / LOUNGE ARMCHAIR
cod 567/AT35
P77 h78 h74 h45 X2



pag 73
MANILA
DIVANO / 2 SEATER SOFA
cod 568/BCO31
P162 h78 h74 h45 X2



pag 75
MANILA
DIVANO / 2 SEATER SOFA
cod 568/AT35
P162 h78 h74 h45 X2



pag 75
DOVER
TAVOLINO / COFFEE TABLE
cod 523/AT-ARDE
P95 P59 P36



pag 73
DOVER
TAVOLINO / COFFEE TABLE
cod 523/BCO-EMP
P95 P59 P36



pag 77
MANILA
POLTRONCINA / DINING ARMCHAIR
cod 716/BCO31
P59 h60 h74 h51 P42 X5



pag 77
MANILA
POLTRONCINA / DINING ARMCHAIR
cod 716/AT35
P59 h60 h74 h51 P42 X5



pag 77
MANILA
POLTRONCINA / DINING ARMCHAIR
cod 716/VER13
P59 h60 h74 h51 P42 X5



pag 78
MANILA
SGABELLO / BARSTOOL
cod 664/BCO31
P56 h55 h102 h80 P42



pag 78
MANILA
SGABELLO / BARSTOOL
cod 664/VER13
P56 h55 h102 h80 P42



pag 78
MANILA
SGABELLO / BARSTOOL
cod 664/AT35
P56 h55 h102 h80 P42



pag 84
BLED
POLTRONA / LOUNGE ARMCHAIR
cod 527/TAU
P92 h83 h76 h43

BLED COLLECTION

DUB COLLECTION



pag 87
BLED
 POLTRONA / LOUNGE ARMCHAIR
 cod 527/AT
 R92 h83 h76 h43



pag 84
BLED
 DIVANO / 2 SEATER SOFA
 cod 528/TAU
 R181 h83 h77 h43



pag 87
BLED
 DIVANO / 2 SEATER SOFA
 cod 528/AT
 R181 h83 h77 h43



pag 84
DOVER
 TAVOLINO / COFFEE TABLE
 cod 523/TAU-EMP
 n95 n59 n36



pag 87
DOVER
 TAVOLINO / COFFEE TABLE
 cod 523/AT-ARDE
 n95 n59 n36



pag 89
BLED
 POLTRONCINA / DINING ARMCHAIR
 cod 722/AT
 R63 h63 h81 h48 h45 x8



pag 89
BLED
 POLTRONCINA / DINING ARMCHAIR
 cod 722/TAU
 R63 h63 h81 h48 h45 x8



pag 93
DUB
 POLTRONA / LOUNGE ARMCHAIR
 cod 500/AT04
 R80 h81 h74 h41 x4



pag 96
DUB
 POLTRONA / LOUNGE ARMCHAIR
 cod 500/AT35
 R80 h81 h74 h41 x4



pag 100
DUB
 POLTRONA / LOUNGE ARMCHAIR
 cod 500/BCO02
 R80 h81 h74 h41 x4



pag 93
DUB
 DIVANO / 2 SEATER SOFA
 cod 501/AT04
 R161 h81 h74 h41 x2



pag 96
DUB
 DIVANO / 2 SEATER SOFA
 cod 501/AT35
 R161 h81 h74 h41 x2



pag 100
DUB
 DIVANO / 2 SEATER SOFA
 cod 501/BCO02
 R161 h81 h74 h41 x2



pag 93
DOVER
 TAVOLINO / COFFEE TABLE
 cod 523/AT-GAL
 n95 n59 n36



pag 96
DOVER
 TAVOLINO / COFFEE TABLE
 cod 523/AT-ARDE
 n95 n59 n36



pag 100
DOVER
 TAVOLINO / COFFEE TABLE
 cod 523/BCO-EMP
 n95 n59 n36



pag 106
DUB
 POLTRONCINA / DINING ARMCHAIR
 cod 718/AT04
 R60 h60 h77 h47 h48 x5



pag 106
DUB
 POLTRONCINA / DINING ARMCHAIR
 cod 718/AT35
 R60 h60 h77 h47 h48 x5



pag 105
DUB
 POLTRONCINA / DINING ARMCHAIR
 cod 718/BCO02
 R60 h60 h77 h47 h48 x5



pag 108
DUB
 SGABELLO / BARSTOOL
 cod 655/AT04
 R57 h52 h98 h77 h45



pag 108
DUB
 SGABELLO / BARSTOOL
 cod 655/AT35
 R57 h52 h98 h77 h45



pag 108
DUB
 SGABELLO / BARSTOOL
 cod 655/BCO02
 R57 h52 h98 h77 h45



pag 114
DUB
 POLTRONA / LOUNGE ARMCHAIR
 cod 505
 R79 h80 h70 h42



pag 114
DUB
 DIVANO 2 POSTI / 2 SEATER SOFA
 cod 506
 R138 h80 h70 h42



pag 114
DUB
 DIVANO 3 POSTI / 3 SEATER SOFA
 cod 507
 R179 h80 h70 h42



pag 114
DUB
 TAVOLINO / COFFEE TABLE
 cod 508
 n93 n58 n36



pag 117
LADY
 POLTRONCINA / DINING ARMCHAIR
 cod 720
 R60 h59 h77 h47 h44



pag 119
DUB
 SGABELLO / BARSTOOL
 cod 650
 R57 h57,5 h98,5 h77 h40



pag 124
BERGEN
 POLTRONA / LOUNGE ARMCHAIR
 cod 542/AT
 R86 h85 h80 h41 x4



pag 124
BERGEN
 DIVANO 2 POSTI / 2 SEATER SOFA
 cod 543/AT
 R168 h85 h80 h41 x2



pag 124
BERGEN
 DIVANO 3 POSTI / 3 SEATER SOFA
 cod 544/AT
 R218 h85 h80 h41 x2



pag 125
BERGEN
 TAVOLINO / COFFEE TABLE
 cod 545/AT
 n75 n75 n28

BERGEN / KARIN / MEGAN / NICOLE

DIVA / LADY



pag 125 
BERGEN
 TAVOLINO / COFFEE TABLE
 cod 547/AT-ARDE
 □75 □75 □28



pag 125 
BERGEN
 TAVOLINO / COFFEE TABLE
 cod 547/AT-FOS
 □75 □75 □28



pag 126 
MEGAN
 POLTRONCINA / DINING ARMCHAIR
 cod 728/AT
 □59 h59,5 h80 h47,5 □47 □x6



pag 129 
KARIN
 POLTRONCINA / DINING ARMCHAIR
 cod 726/AT
 □60 h58 h78 h48 □47 □x6



pag 130 
KARIN - MEGAN
 CUSCINO / CUSHION
 cod 1530/04



pag 130 
KARIN - MEGAN
 CUSCINO / CUSHION
 cod 1530/98



pag 132 
NICOLE
 SEDIA / CHAIR
 cod 727/AT
 □45,5 h57 h82 h47 □44 □x8



pag 134 
BERGEN
 LETTINO / SUNLOUNGER
 cod 604/AT
 □75 □210 □34

GAUDÌ / PRAGA / ARIEL / DUKE



pag 140 
GAUDÌ
 POLTRONCINA / DINING ARMCHAIR
 cod 731/AT
 □56 h58 h80 h45 □51 □x8



pag 140 
GAUDÌ
 POLTRONCINA / DINING ARMCHAIR
 cod 731/TAU
 □56 h58 h80 h45 □51 □x8



pag 143 
PRAGA
 POLTRONCINA / DINING ARMCHAIR
 cod 793/AT
 □58 h56 h77 h44,5 □50 □x7



pag 143 
PRAGA
 POLTRONCINA / DINING ARMCHAIR
 cod 793/BCO
 □58 h56 h77 h44,5 □50 □x7



pag 143 
PRAGA
 POLTRONCINA / DINING ARMCHAIR
 cod 793/TAU
 □58 h56 h77 h44,5 □50 □x7



pag 144 
ARIEL
 SEDIA / CHAIR
 cod 794/AT
 □53,5 h54 h77 h44,5 □44 □x9



pag 144 
ARIEL
 SEDIA / CHAIR
 cod 794/BCO
 □53,5 h54 h77 h44,5 □44 □x9



pag 144 
ARIEL
 SEDIA / CHAIR
 cod 794/TAU
 □53,5 h54 h77 h44,5 □44 □x9



pag 146 
DUKE
 SGABELLO / BARSTOOL
 cod 658/AT
 □54 h58 h113 h80 □41 □x6



pag 146 
DUKE
 SGABELLO / BARSTOOL
 cod 658/TAU
 □54 h58 h113 h80 □41 □x6

PAVILLON SERVICE



pag 148 
PAVILLON
 SERVICE
 cod 645
 □500 □370 □270

GAZEBO



pag 158 
HONOLULU
 GAZEBO
 cod 640
 □205 □210 □250



pag 160 
KUTA
 GAZEBO
 cod 642
 □195 □208 □212

Le misure riportate nel presente catalogo sono da ritenersi approssimative. Differenze di tonalità dei materiali rispetto a quanto illustrato nel catalogo non possono essere causa di contestazioni. Contral si riserva il diritto di apportare modifiche agli articoli in qualsiasi momento.

The measurements shown in this catalogue are to be considered approximate. Differences in the materials' colors compared to what is shown in the catalogue cannot be the cause of complaints. Contral has the right to make changes to the models in any moment.



Tutti i prodotti Contral sono assicurati da UnipolSai Assicurazioni contro eventuali danni provocati agli utilizzatori.

All Contral's products are insured by UnipolSai Assicurazioni against any damage caused to the users.

USO & MANUTENZIONE

PIOGGIA E NEVE

I cuscini dei prodotti Contral sono idrorepellenti e in caso di breve contatto con l'acqua si asciugano semplicemente lasciandoli al sole per pochi minuti. In caso di forti piogge o nevicate si raccomanda di riporre i cuscini al coperto. Nell'eventualità di esposizione a piogge prolungate o di accidentale immersione in acqua si consiglia di sfoderare i cuscini e lasciare asciugare completamente fodere e imbottiture prima di ricomporli, evitando così la formazione di muffe.

The cushions of Contral products are water repellent and in the event of a short time with water they dry completely leaving them in the sun for a few minutes. It is recommended to store the cushions indoors in case of heavy rain or snow. In the event of exposure to prolonged rains or accidental immersion in water, it is advisable to remove the cushions' covers and allow them and the paddings to dry completely before reassembling them, avoiding the formation of mold.

PULIZIA CORDE

Le corde sintetiche utilizzate sono resistenti alle macchie e facilmente lavabili con acqua corrente. Nel caso di macchie persistenti tamponare con acqua calda e detergente per tessuti e poi risciacquare con acqua corrente. Non utilizzare detersivi con candeggina. Non utilizzare idropulitrici. Dopo la pulizia lasciare asciugare completamente prima di riporre i prodotti al chiuso o di coprirli con teli protettivi.

The synthetic ropes used are stain resistant and easily washable with running water. In the case of persistent stains, dab with warm water and detergent for fabrics and then rinse with running water. Do not use detergents with bleach. Do not use pressure washers. After cleaning, allow to dry completely before storing the products indoors or covering them with protective sheets.

PULIZIA TELAI

Pulire le strutture di metallo con acqua, sapone neutro e una spugna. Dopo la pulizia risciacquare accuratamente e lasciare asciugare completamente prima di riporre i prodotti al chiuso o di coprirli con teli protettivi. Non utilizzare idropulitrici.

Clean the metal structures with water, mild soap and a sponge. After cleaning, rinse thoroughly and allow to dry completely before storing them indoors or covering them with protective sheets. Do not use pressure washers.

PULIZIA TESSUTI PVC

I tessuti PVC usati sono resistenti alle macchie e facilmente lavabili con acqua corrente. Nel caso di macchie persistenti tamponare con acqua calda e detergente per tessuti e poi risciacquare con acqua corrente. Non utilizzare detersivi con candeggina. Non utilizzare idropulitrici. Dopo la pulizia lasciare asciugare completamente prima di riporre i prodotti al chiuso o di coprirli con teli protettivi.

The PVC fabrics used are stain resistant and easily washable with running water. In the case of persistent stains, dab with warm water and detergent for fabrics and then rinse with running water. Do not use detergents with bleach. Do not use pressure washers. After cleaning, allow to dry completely before storing the products indoors or covering them with protective sheets.

PULIZIA IMBOTTITURE

Le imbottiture sono lavabili con acqua corrente e sapone neutro. Non utilizzare idropulitrici. Non utilizzare detersivi con candeggina o solventi. Dopo la pulizia lasciare asciugare completamente prima di reinserire le imbottiture nelle fodere.

The paddings are washable with running water and neutral soap. Do not use pressure washers. Do not use detergents with bleach or solvents. After cleaning, allow to dry completely before reinserting the padding into the covers.

PULIZIA TESSUTI IN POLIESTERE

I tessuti in poliestere possono essere lavati in lavatrice a 30° con detergente neutro. Non utilizzare detersivi con candeggina. Non utilizzare idropulitrici. Non lavare a secco. Non stirare. Dopo la pulizia lasciare asciugare completamente prima di riporre i prodotti al chiuso o di coprirli con teli protettivi.

Polyester fabrics can be machine washed at 30° with neutral detergent. Do not use bleach cleaners. Do not use pressure washers. Do not dry clean. Do not iron. After cleaning, allow to dry completely before storing the products indoors or covering them with protective sheets.



INDICE TIPOLOGICO

LOUNGE SET

LAKE 8
LEAF 24
METHOD 42
MANILA 68
BLED 80
DUB 90
DIVA 110
BERGEN 120

SEDIE / POLTRONCINE

LAKE 18
LEAF 36
METHOD 52
CLOE 60
MANILA 76
BLED 88
DUB 104
LADY 116
MEGAN 126
KARIN 128
NICOLE 132
GAUDÌ 138
PRAGA 142
ARIEL 144

SGABELLI

LAKE 22
LEAF 40
METHOD 56

CLOE 66
MANILA 78
DUB 108
DIVA 118
DUKE 146

LETTINI

BERGEN 134

TAVOLINI

LEAF 27
DOVER 46
DIVA 114
BERGEN 13

PAVILLON SERVICE 148

GAZEBO

HONOLULU 158
KUTA 160

Per una ricerca del prodotto attraverso le collezioni si può consultare l'indice a inizio volume.

For a product search by collection, you can consult the index at the beginning of the book.

Contral srl

Via Roma 261/24
31020 Villorba (Treviso) Italy
T +39 0422 444 850
F +39 0422 444 858
contral@contral.it
www.contral.it

Credits

Graphic design - StudioPANG
Printing - Grafiche Italprint Srl
Fotografie - Franco Lazzarin
e Michele Salucci / ImmaginAria

Thanks to

Ristorante Da Gigetto - Miane (TV)
Hotel Relais Villa Cornér della Regina -
Cavasagra di Vedelago (TV)

© Proprietà esclusiva di Contral S.r.l. È vietata la riproduzione, anche parziale, del presente catalogo in qualsiasi formato senza preventiva autorizzazione.

© Exclusive property of Contral S.r.l. Reproduction, even partial, of this catalog is forbidden in any format without prior permission.

